

d 30~100mm

Boundary Dimensions						Basic Load Ratings	
d	D	B	C	r _{1,2min}	r _{3,4min}	Dynamic C	Static C ₀
mm						kN	
30	60.03	37	37	2.5	0.4	61.5	87.7
34	64	37	37	2.5	1	60	82
35	64	37	37	2.5	1	60	82
	80	57	45	2	0.5		
42	76	39	39	2	1.5	67.6	105.5
49	84	48	48	2.8	0.5	97.3	171
	84	48	48	2.8	0.5	94.6	165
50	84	54	54	5.5	1.5	106	236
	100	50	50	5.5	1.5	137	195
	100	79	54	2	0.8		
	100	79	54	2	0.8		
55	90	52	43	3.5	0.2	142	220
	100	60	48.5	2	0.6	192	281
65	120	73	61.5	2	0.6	279	424
70	110	38	28	1	0.5	104	156
75	130	75	62	2	0.3	294	466
	130	75	62	2.5	0.5		
78	130	90		1.5	0.6	244	443
80	140	78	63.5	2.5	0.6	339	526
85	150	86	69	2.5	0.6	406	647
90	160	94	77	2.5	0.6	405	535
95	145	76	64	2.5	0.6	385	580
	170	100	100	3	1	543	897
100	180	100	84	1.5	0.6	603	1010
	180	107	87	3	1	603	1010
	180	112	92	3	1	603	1010

Bearing Designations		Mounting Dimensions					Calculation Factors				Mass
Present	Original	d _{amax}	D _{amin}	a ₂	r _{amax}	r _{omax}	Y ₁	Y ₂	Y ₀	e	kg
		mm									
350606-2LS		42	56	0	2	2	1.5	2.19	1.4	0.46	0.491
3506/34X3TN1-2RS		46	61.5	0	2	2	1.5	2.19	1.4	0.46	0.483
350607X3TN1-2RS	57707	47	61.5	0	2	2	1.5	2.19	1.4	0.46	0.467
		60	76.5	7	2	2	1.21	1.84	1.21	0.55	1.22
3506/42X3TN1-2RS		58	71	0	2	2	1.21	1.84	1.21	0.55	0.644
3506/49-2LS		63	79	0	2.5	2.5	1.5	2.19	1.4	0.46	1.13
3506/49TN1-2LS		63	79	0	2.5	2.5	1.5	2.19	1.4	0.46	1.1
350610X3TN1-2RS		65	79	0	4	4	1.5	2.19	1.4	0.46	1.19
	LY-3021	59	90	0	1.5	1.5	1.6	2.4	1.6	0.42	1.62
	797710	62	88	13	2	2	1.6	2.4	1.6	0.42	2.45
	797710 K	62	88	13	2	2	1.6	2.4	1.6	0.42	2.44
32011X2/DF	3-762	69	87	6	2.5	0.2	1.7	2.5	1.6	0.4	1.23
352211		64	96	6	2	0.6	1.7	2.5	1.6	0.4	1.83
352213		75	116	6	2	2	1.63	2.48	1.63	0.4	3.35
350014 X2	97814	78	104	7	1	0.5	1.5	2.2	1.4	0.46	1.06
352215	97515	84	125	6.5	2	0.3	1.6	2.3	1.5	0.43	3.62
	B97515L	87	125	6	2	0.5	1.6	2.3	1.5	0.43	3.62
DU7813090		94	125				1.59	2.37	1.56	0.42	4.58
352216		90	135	7.5	2	0.6	1.57	2.39	1.57	0.42	4.48
352217		95	143	8.5	2	0.6	1.61	2.39	1.57	0.42	5.85
352218	97518E	102	153	8.5	2	0.6	1.6	2.4	1.6	0.42	7.21
	697819K										4.56
352219		108	165	10	2.5	1	1.6	2.4	0.42	1.6	9.16
	B697820L	114	170	10	2	0.8	1.61	2.39	1.57	0.42	9.27
352220		114	171	10	2	0.8	1.6	2.4	1.6	0.42	10.9
352220 X2		114	175	14	3	1	1.86	2.83	1.86	0.36	11

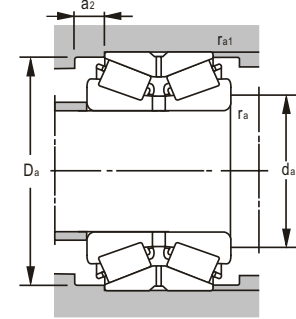
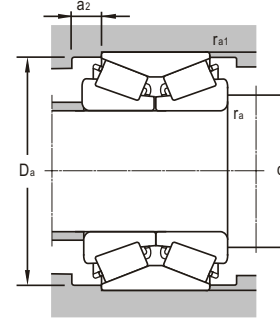
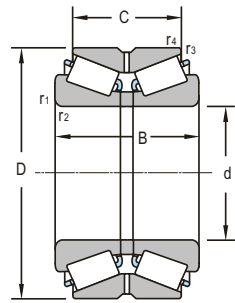
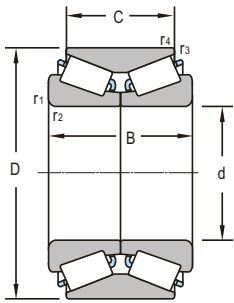

d 100~200mm

Boundary Dimensions						Basic Load Ratings	
d	D	B	C	r _{1,2min}	r _{3,4min}	Dynamic C	Static C ₀
mm						kN	
100	190	125	100	3	1.3	651	1200
110	180	95	76	2	0.6	473	839
	200	121	101	3	1	763	1310
	200	121	101	3	1.2	764	1308
	200	124	102	3	1	763	1310
120	180	86	86	2.5	0.5	394	788
	200	110	90	2.5	0.6	663	900
	200	110	90	2	0.6	663	900
	215	58	109	3	1	858	1520
	215	132	109	3	1	843	1480
130	200	95	75	2.5	0.6	425	958
	200	110.4	110.4	2.5	0.5	542	1060
	210	110	90	2	0.6	618	1150
	230	149	120	4	1	916	1680
	230	222	150	3	1	842	957
140	210	95	75	2.5	0.6	498	924
	210	100	100	2.5	0.5	538	1066
150	320			5	1.5	1370	2140
160	240	115	90	3	1	670	1062
	240	116		3	1	719	1470
	270	140	120	2.5	1	947	2020
	270	150	120	2.5	1	947	2020
170	260	120	95	3	1	811	1630
	260	128	100	3	1	833	1458
180	250	102	80	2.5	0.6	519	1370
	250	95	74	2.5	0.6	504	1263
	280	134	108	3	1.2	972	1930
	280	150	150	3	0.9	1048	2140
	300	164	134	3	1	1260	2510
190	260	95	75	2.5	0.6	574	1400
	320	170	130	3	1	1410	2720
200	280	110	85	3	1	615	1670
	280	116	92	3	1	758	1700

Bearing Designations		Mounting Dimensions					Calculation Factors				Mass
Present	Original	d _{amax}	D _{amin}	a ₂	r _{amax}	r _{amax}	Y ₁	Y ₂	Y ₀	e	kg
		mm									
350620D1		118	175	14	3	2	1.86	2.83	1.86	0.36	15.4
352122	2097722	120	175	10	2	0.6	2.32	3.53	2.32	0.28	8.63
		124	193	11	2.5	0.8	1.57	2.39	1.57	0.42	15.7
	LY-3028	124	190	10	2.5	0.8	1.61	2.39	1.57	0.42	16
		124	193	11	2.5	1	1.57	2.39	1.57	0.42	16
352222X2											
32024T86/DB		130	173	11	2	0.5	1.8	2.7	0.37	1.8	6.74
352124	2097724	130	194	12	2	0.6	2.2	3.3	2.2	0.3	12
	2697724	130	187	12	2	2	2.7	4.11	2.7	0.24	12
352224YA		132	206		2.5	1	1.5	2.3	1.5	0.44	19.5
352224		134	205	13	2.5	1	1.52	2.32	1.52	0.44	19.5
352026 X2	2097126	142	188		2	0.6	1.88	2.87	1.88	0.35	10.1
32023/DB		144	194	11	2	0.5	1.6	2.3	0.43	1.6	11.5
352126	2097726	140	198	8	2	0.6	1.8	2.7	1.8	0.37	13.5
352226 X2		148	215	15	3	1	2.6	3.8	2.5	0.26	24.6
350626SC	197726	141	203	12	2.5	1	2.6	3.8	2.5	0.26	30.2
352028 RX2	2697128	147	200	12	2	0.6	1.8	2.7	1.8	0.37	12.1
32028T100/DB		153	202	11	2	0.5	1.5	2.2	0.46	1.4	11.2
351330X2		182	308				1.87	2.88	1.85	0.36	55
352032 RX2	2697132	168	228	14	2.5	1	1.8	2.7	1.8	0.37	14.9
352032		178	220				1.45	2.16	1.42	0.46	16.5
352132 X2		172	252	12	2	1	2.1	3.2	2.1	0.32	31
352132	2097732	172	252	16	2	1	2.1	3.2	2.1	0.32	31.6
352034 X2	2097134	184	250	13	3	1	1.48	2.26	1.48	0.44	21.2
352034YA	2097134K	183	248	14	2.5	1	2.2	3.2	2.1	0.31	21
352936		192	242	11	2	0.6	1.37	2.09	1.37	0.48	14.2
352936 X2	2097936	192	239	11	2	0.6	1.76	2.68	1.76	0.37	13.1
352036 X2	2097136	194	263	13	2.5	1	2.32	3.53	2.32	0.28	28
32036T150X/DB		199	268	16	2.5	0.9	2.4	3.6	0.28	2.3	30.7
352136	2097736	194	279	14	2.5	1	2.46	3.93	2.58	0.26	39.3
352938X2D1		200	253	9.5	2	0.6	1.76	2.62	1.72	0.38	14
352138	2097738	204	298	20	2.5	1	2.3	3.5	2.3	0.28	50.4
352940 X2	2097940	214	266	13	2.5	1	1.66	2.53	1.66	0.39	19.7
352940 X2/YA	2097940EK	214	273	14	2.5	1	1.8	2.6	1.7	0.39	22

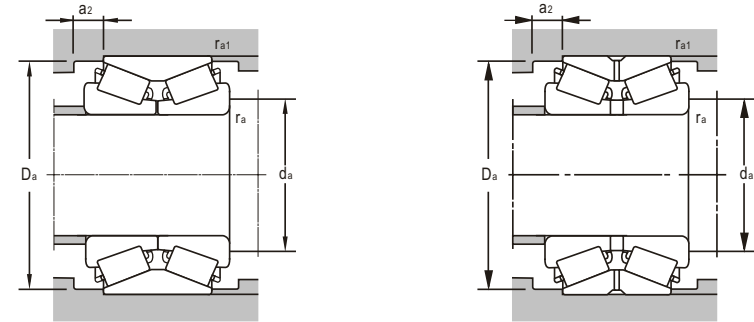
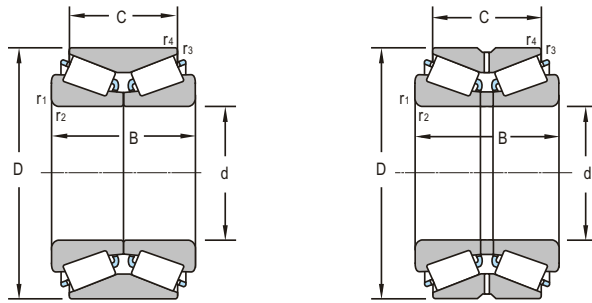

d 200~340mm

Boundary Dimensions						Basic Load Ratings	
d	D	B	C	r _{1,2min}	r _{3,4min}	Dynamic C	Static C ₀
mm						kN	
200	310	152	120	3	1	1210	2480
205	320	150	110	5	2	1080	2180
220	300	110	88	3	1	780	1870
	340	113	90	4	1.5	942	1720
	340	165	130	4	1	1370	2760
	340	130		4	1	1410	2860
	370	195	150	4	1.1	1850	3670
240	320	110	90	3	1	811	1950
	360	165	128	4	1	1340	3120
	390	185		4	1.5	2440	5220
	400	160	128	5	1.5	1570	3370
	440	294	240	4	1	3349	5508
260	360	134	108	3	1	1263	2430
	360	134	108	3	0.9	1263	2430
	400	185	146	3.5	1.5	1955	2600
	400			5	1.1	1890	4250
	400	190	190	5	1.1	1890	4250
	430	180	130	7.5	1.5	2737	3016
	440	225	180	4	1.1	2630	5190
280	380	134	108	2.5	1	1328	1885
	420	133	106	4	2	1270	1936
	420	186	146	5	1.1	1570	4000
300	420	160	128	4	1	1700	4270
	420	175	136	5	1	1800	2629
	440	140	100	5	1	2560	4440
	460	210	165	5	1.1	2278	4148
	500	205	152	5	1.5	2618	4165
320	440	160	128	4	1	1650	3900
	480	210	160	5	1.1	2540	5750
340	460	160	128	4	1	1575	4050
	520	180	135	5	1.5	2060	4100
	580	242	170	5	1.5	3100	6000

Bearing Designations		Mounting Dimensions					Calculation Factors				Mass
Present	Original	d _{amax}	D _{amin}	a ₂	r _{amax}	r _{amax}	Y ₁	Y ₂	Y ₀	e	kg
		mm									
352040 X2		212	297	10.5	2	1	1.7	2.6	1.7	0.39	39.6
350641D1		216	314	12	2.5	2	1.7	2.6	1.7	0.39	40.2
352944 X2		231	292	11.5	2.5	1	1.6	2.4	1.6	0.43	21.2
351044		234	319	11.5	3	1.5	1.8	2.69	1.76	0.37	33.1
352044 X2		238	324	19	3	1	2	2.9	2	0.34	49.4
352044X2A/HCP6		234	331				1.9	2.9	1.9	0.35	49.8
352144		238	341	15	3	1.5	1.83	2.72	1.79	0.37	78.2
352948 X2		254	314	12	2.5	2.5	1.4	2.19	1.4	0.46	22.6
352048 X2		258	340	20	3	3	1.9	2.89	1.9	0.35	55.2
355148X3		276	370				2.05	3.05	2	0.33	101
32248 X2/DB	240 KBE 031+L 3-745	264	380	18	4	1.5	1.69	2.57	1.69	0.39	75.2
		252	427	2.6	3	1	1.6	2.3	7.5	0.43	174
352952 X2	2097952	274	350	16	2.5	1	1.8	2.7	1.8	0.37	36.8
352952 X2/YA	2097952K	274	350	16	2.5	1	1.8	2.7	1.8	0.37	36.8
352052 X2	2097152	277	380	22	4	1	2.3	3.3	2.2	0.3	76.8
352052X2A/HCP6		318	382				1.5	2.24	1.47	0.43	84
352052/W33		277	380	22	4	1	1.6	2.3	0.43	1.6	82
350652	97752	285	398	25	6	1.5	2	2.9	2	0.34	93.4
352152		278	418	25	3	3	1.76	2.68	1.76	0.37	131
352956 X2	2097956	294	371	16	2.5	1	2.3	3.4	2.3	0.29	41.3
351056 X2	97156	302	397	14	3	2	2.2	3.3	2.2	0.3	58.1
352056 X2		302	400	20	4	4	1.8	2.7	1.8	0.37	84.6
352960 X2	2097960	317	408	18	3	1	2.4	3.6	2.3	0.28	63
352960/YB2	97760	315	405	14	4	1	1.9	2.8	1.9	0.36	65.6
350660 D	37860	327	420	22	4	1	1.5	2.3	1.5	0.44	58.42
352060 X2	2097160	320	445	24	4	1	2.2	3.2	2.1	0.31	117
351160	1097760	327	470	28	4	1.5	2.1	3.2	2.1	0.32	143
352964 X2	2097964	335	427	18	3	1	2.3	3.3	2.2	0.3	67
352064 X2	2097164	345	456	25	4	1	1.6	2.4	1.6	0.42	122
352968 X2	2097968	355	448	18	3	1	2.2	3.2	2.1	0.31	71
351068	97168	360	501	27	4	1.5	2.3	3.4	2.3	0.29	119
351168	1097768	368	555	38	4	1.5	1.6	2.4	1.6	0.42	214

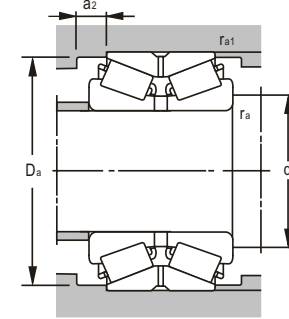
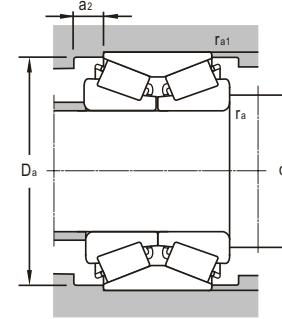
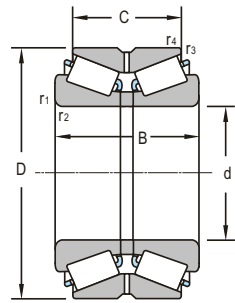
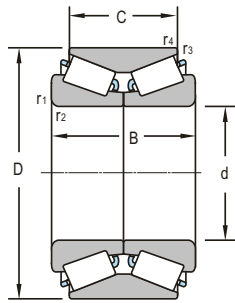

d 350--530mm

Boundary Dimensions						Basic Load Ratings	
d	D	B	C	r _{1,2min}	r _{3,4min}	Dynamic C	Static C ₀
mm						kN	
350	590	200	140	9.5	1.5	1992	3367
360	480	160	128	4	1	1640	2847
	530	155	110	5	1.5	1344	2800
	530	155	110	5	1.5	1344	2800
	540	185	140	5	1.5	2800	6300
	600	242	170	5	1.5	3410	6800
380	520	145	105	4	1.1	1660	3800
	560	190	140	5	1.5	2880	6300
	620	242	170	5	1.5	3410	6850
400	540	150	105	4	1.1	1650	3550
	590	185	123	5	2	1500	3080
	600	206	150	5	1.5	2890	6300
420	560	145	105	4	1.1	1880	4450
	620	190	125	5	1	1470	2490
	620	206	150	5	1.5	2670	5880
	700	275	200	6	2.5	4430	9150
440	600	170	125	4	1.1	1390	2560
	650	212	152	6	2.5	4950	10400
	720	190	126	6	2.5	4580	9430
	720	283	226	6	3	5300	11700
460	620	174	130	4	1.1	1410	2630
	680	175	230	6	2.5	3024	6732
480	650	180	130	5	1.5	2150	5150
	700	240	180	6	2.5	2928	5316
490	640	180	144	7.5	3	1716	3549
500	670	180	130	5	1.5	1884	3740
	720	236	180	6	2.5	3580	8150
520	740	190	120	2.5	2.5	2158	3913
530	710	190	136	5	1.5	2670	6300
	780	231	231	6	3	4550	10100

Bearing Designations		Mounting Dimensions					Calculation Factors				Mass
Present	Original	d _{amax}	D _{amin}	a ₂	r _{amax}	r _{amax}	Y ₁	Y ₂	Y ₀	e	kg
		mm									
350670	97770	368	566	32	8	1.5	1.6	2.4	1.6	0.42	212
352972 X2	2097972	376	468	18	3	1	2.1	3.1	2	0.33	74.3
350672	97772	378	510	25	4	1.5	1.7	2.5	1.6	0.4	107
350672 D1	37772	378	510	25	4	1.5	1.7	2.5	1.6	0.4	109
351072	97172	380	522	27	4	1.5	2.3	3.3	2.2	0.3	127
351172	1097772	390	575	38	4	1.5	1.5	2.3	1.5	0.44	235
351976	1097976	402	505	22	3	1	1.6	2.3	1.6	0.43	80.3
351076	97176	406	542	27	4	1.5	2.2	3.2	2.1	0.31	146
351176	1097776	405	598	38	4	1.5	1.5	3.2	1.4	0.46	243
351980	1097980	420	525	24	3	1	1.6	2.2	1.5	0.45	86.9
350180 D	37780	420	558	35	4	2	2.2	3.2	2.1	0.31	166
351080	97180	420	580	30	4	1.5	1.7	2.5	1.7	0.4	180
351984	1097984	440	546	24	3	1	2.2	2.3	2.1	0.31	88.7
350184 D	37784	440	598	34	4	1	2.1	3.2	2.1	0.35	171
351084	97184	448	601	30	4	1.5	1.6	2.5	1.6	0.41	187
351184	1097784	460	670	40	5	2	2.1	3.1	2.1	0.32	392
351988	1097988	460	585	24	3	1	1.8	2.6	1.7	0.39	114
351088	97188	469	629	32	5	2	1.6	2.3	1.5	0.43	213
351188		480	700				1.45	2.16	1.42	0.46	404
440KBE03194+L		468	678	28.5	5	2.5	1.68	2.5	1.64	0.4	443
351992	1097992	480	605	24	3	1	1.7	2.5	1.7	0.4	130
351092	97192	489	657	32	5	2	2.2	3.2	2.1	0.31	253
351996	1097996	520	633	27	4	1.5	1.6	2.4	1.6	0.42	151
351096	97196	511	671	32	5	2	2.1	3.1	2.1	0.32	281
350698	97798	514	615	20	6	2.5	1.8	2.7	1.8	0.37	140
3519/500	10979/500	524	650	27	4	1.5	1.5	2.3	1.5	0.44	159
3510/500	971/500	530	682	28	5	2	2	3	2	0.33	289
3506/520	977/520	546	712	37	2	2	1.6	2.4	1.6	0.42	231
3519/530	10979/530	554	683	29	4	1.5	1.6	2.5	1.6	0.41	190
3509/530X1		560	760	24	5	2.5	1.8	2.7	0.37	1.8	355

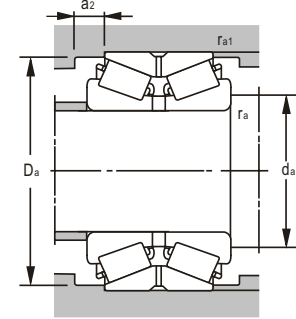
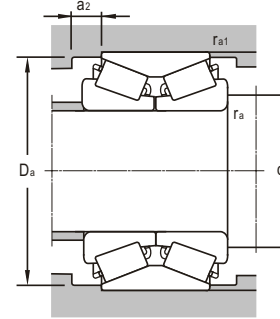
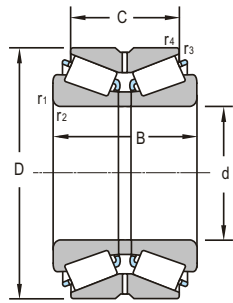
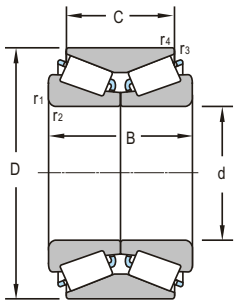

d 560~1600mm

Boundary Dimensions						Basic Load Ratings	
d	D	B	C	r _{1,2min}	r _{3,4min}	Dynamic C	Static C ₀
mm						kN	
560	750	213	156	5	1.5	4081	8880
	820	260	185	6	2.5	4785	9216
600	800	205	156	5	1.5	2772	5832
	800	190	190	5	4	4070	10900
	870	270	198	6	2.5	3828	6912
	870	270	270	6	6	6520	16700
630	850	242	182	6	2.5	4095	8205
670	900	240	180	6	2.5	4260	8970
	980	230	230	10	10	4880	11600
710	950	240	175	6	2.5	4425	9600
	1030	236	208	7.5	4	5310	11520
711.2	914.4	190.5	190.5	6.4	1.5	3560	9430
720	915	190	140	2	5	3451	6681
750	1000	264	194	6	2.5	5370	11175
800	1060	270	204	6	2.5	6086	13464
	1060	270	270	6	1.8	5420	15400
850	1120	268	188	6	2.5	6188	14042
900	1180			6	4	6480	18400
950	1250	300	220	7.5	3	8347	18360
1120	1460	335	250	7.5	3	10319	23290
1370	1605	210	210	7.5	4	5860	20300
1450	1770	290	290	9.5	5	7780	27200
	2050	450	450	9.5	5	18700	60200
1600	2060	560	360	9.5	4	21420	57970

Bearing Designations		Mounting Dimensions					Calculation Factors				Mass
Present	Original	d _{amax}	D _{amin}	a ₂	r _{amax}	r _{bmax}	Y ₁	Y ₂	Y ₀	e	kg
		mm									
3519/560	10979/560	580	725	16	4	1.5	1	1.5	1	0.44	235
3510/560	971/560	594	795	39	5	2	1.7	2.5	1.7	0.4	409
3519/600	10979/600	625	779	30	4	1.5	2.1	3.1	2	0.33	266
3706/600											
3510/600	971/600	630	845	39	5	2	1.6	2.5	1.6	0.41	500
3710/600											
3519/630	10979/630	657	829	32	5	2	1.7	2.5	1.7	0.4	368
3519/670	10979/670	703	875	32	5	2	1.6	2.3	1.5	0.43	416
3706/670B/YA6 C3											
3519/710	10979/710	743	925	34	5	2	1.5	2.2	1.4	0.46	444
3510/710 X2	977/710	810	995	14	6	3	1.8	2.6	1.7	0.39	651
3506/711.2	977/720	736	887	25	6	1.5	1.76	2.62	0.38	1.72	281
3506/720	10979/750	756	890	27	2	4	1.9	2.9	1.9	0.35	277
3519/750	10979/800	783	978	37	5	2	1.7	2.5	1.6	0.4	499
3519/800		838	1031	37	5	2	1.9	2.9	1.9	0.35	604
3519/800-1/P69	10979/850	838	1031	37	5	1.5	1.9	2.9	0.35	1.9	604
3519/850	10979/950	886	1093	42	5	2	1.5	2.2	1.5	0.46	636
319/900/DB											704
3519/950	10979/1120	994	1220	42	6	2.5	2	3	2	0.33	909
3506/1120	978/1600	1170	1427	45	6	2.5	1.9	2.9	1.9	0.35	1344
3506/1370		1403	1581	35	6	3	1.7	2.5	0.4	1.7	677
3506/1450		1490	1747	50	8	4	0.78	1.2	0.87	0.76	1348
3519/1600		1653	2014	50	8	4	1.7	2.5	0.4	1.7	3459
3506/1600		1780	2035	52	8	3	0.5	0.8	0.5	1.26	4210

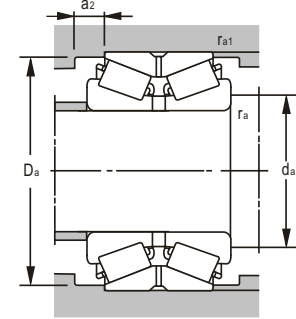
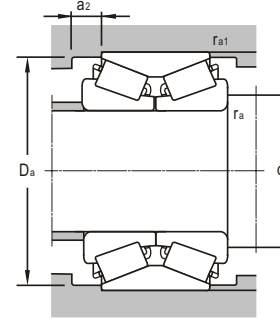
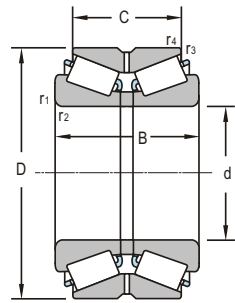
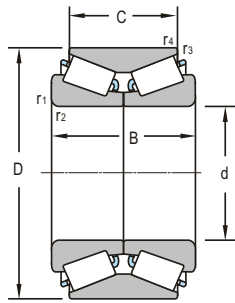

d 88.9~317.5mm

Boundary Dimensions						Basic Load Ratings	
d	D	B	C	r _{1,2min}	r _{3,4min}	Dynamic C	Static C ₀
mm						kN	
88.9	161.925	104.775	85.725	3.5	1.5	467	778
99.995	225	119.962	117	3.3	0.8	605	1060
111.125	190.5	106.362	80.962	3.5	1.5	412	845
114.3	279.4	185.24	127.85	6.4	1.5	1190	1740
127.792	228.6	84.138		3.5	2.3	599	1040
177.8	288.925	142.875	111.125	7	1.5	1070	1220
200.025	317.5	146.05	111.125	4.3	1.5	1180	2450
203.2	276.225	95.25	73.025	3.5	0.8	629	1044
	292.1	109.538	84.138	3.5	0.8	727	1500
	368.3	158.75	152.4	3.2	3.2		
	406.4	196.85	127	4	2	2006	2952
228.6	355.6		111.125	7	1.3	1340	2630
228.6	358.775	152.4	117.475	3.5	1.5	1190	3110
	488.95	345	220	6	1.5	3260	6180
241.3	444.5	209.55	158.75	6.4	1.5	2460	4590
247.65	406.4	247.65	203.2	6.4	1.6	2450	5330
254	347.662	101.6	69.85	3.5	1.5	850	1386
292.1	469.9	200.025	149.225	9.7	1.5	2008	2632
300.038	422.275	174.625	136.525	4	1	1785	2805
304.8	393.7	107.95	82.55	6	1.5	901	1854
	393.7	107.95	82.55	6	1.5	922	2370
	421.75	123.825	92.075	6.4	1.5	1040	2490
	438.048	161.925	123.825	6.4	1	1521	2157
	546.1	376	314	8		5320	6040
317.5	447.675	180.975	146.05	3.5	3.5	2040	5080

Bearing Designations		Mounting Dimensions					Calculation Factors				Mass	
Present	Original	d _{amax}	D _{amin}	a ₂	r _{amax}	r _{amax}	Y ₁	Y ₂	Y ₀	e	kg	
		mm										kg
NA759/752D		102	150	15	3.5	1.5					8.56	
H221647NA/K426864		114	200	6	0.3	3	2	3	2	0.33	25.1	
71437/71751D		125	180	14	3	2.5	1.6	2.4	1.6	0.42	11.9	
	LY-3018										50.1	
HM926749/HM926710D		156	219			3.5	2.3	0.92	1.36	0.74	18.4	
HM237545/HM237510CD		189	266	18	4	18	2.1	3.2	2.1	0.32	33	
93787/93127D		225	300	20	4	1.5	1.3	1.9	0.52	1.3	39.1	
3506/203.2D/YA3	37941K	214	268	14	2.5	1	2.1	3.1	2	0.32	14.6	
M541349/M541310CD		220	285	25	3.5	0.8	1.7	2.5	1.6	0.4	21.4	
EE420800D/421450	3-758	220	340	6	3.2	3.2	1.7	2.5	1.6	0.4	76.2	
EE114080/114161DC	3-730	228	375	37	4	2	0.9	1.3	0.8	0.78	107	
EE130902/131401CD		238	330	340	6	6.4	1.6	2.04	3.04	2	0.33	49.3
M249732/M249710CD		242	350	14	3.5	1.5	2	3	2	0.33	56.7	
	LY-3020										293	
EE923095/923176D		295	423	26	6.4	1.5	2	3	2	0.34	130	
46T504125GWH											121	
LM249747NW/LM249710D	37951K	270	335	16	2.5	1	2	3	2	0.33	23.9	
EE72215/722186CD		315	450	26	1.5	9.7	1.8	2.7	1.8	0.37	122	
HM256849/HM256810D	97960	320	410	22	4	1	1.9	2.8	1.9	0.35	65.6	
L357049/L357010D	37961K	324	386	20	5	1.5	1.9	2.7	1.8	0.36	30.1	
L357049NW/L357011D/HC3		324	386	20	5	1.5	1.9	2.7	1.8	0.36	30.2	
EE109120/109163D		335	399	15	6	1.5	1.6	2.3	1.6	0.43	43.6	
NA329120/329173D	3-769	340	420	20	5	1	2	3	2	0.34	65.4	
	LY-3009										374	
HM259049/HM25910CD		341	431	18	3	3	2	3	2	0.33	84.6	

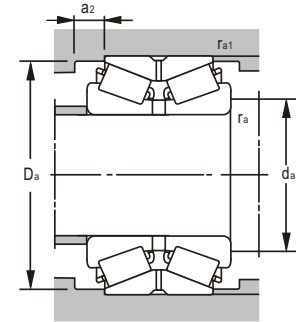
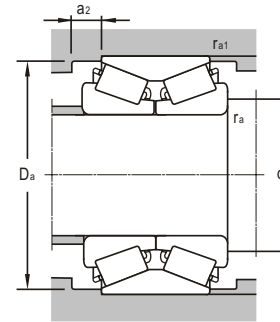
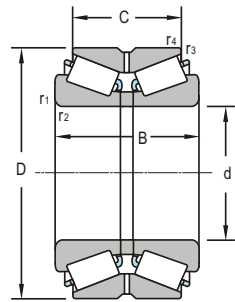
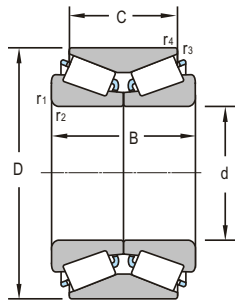

d 368.249 ~ 1041.4mm

Boundary Dimensions						Basic Load Ratings	
d	D	B	C	r _{1,2min}	r _{3,4min}	Dynamic C	Static C ₀
mm						kN	
368.249	523.875	214.312	169.862	6.4	1.5	2570	4650
368.3	523.875	185.738	185.738	3.3	6.4	2450	6730
	596.9	203.2	133.35	9.5	2.5	2490	3650
371.475	501.65	155.575	107.95	6	1	1720	4050
415.925	590.55	244.475	193.675	6.4	1.5	3230	8280
431.8	565.15	100.22	73.5	3.3	1.5	1040	2880
479.425	679.45	276.225	222.25	4.5	1.5	4730	12300
498.475	634.873	177.8	142.875	4.5	1	2550	6990
533.4	812.8		187.325	9.7	3.3	5200	11800
558.8	736.6	225.425	177.8	6	1	4020	11000
	742.95	187.328	138.112	4.5	1.5	2610	5220
600.5	793.75	165.1	115.087	6.4	3.2	1360	3430
1041.4	1235.075	166.7	108	6.4	3.2	1440	4770

Bearing Designations		Mounting Dimensions					Calculation Factors				Mass
Present	Original	d _{max}	D _{min}	a ₂	r _{amax}	r _{bmax}	Y ₁	Y ₂	Y ₀	e	kg
		mm									
HM265049/HM265010D	3-743	386	510	14	5	1	2	3	2	0.33	143
HM265049TDS/HM265010S	97974	394	580	37	8	2	1.4	2.1	1.4	0.48	141
											EE181453/182351D
EE231462/231976DC	3-726	394	485	26	5	1	1.5	2.3	1.5	0.44	79
M268749/M268710CD	LY-3019	451	561	25	6	1.5	2	3	2	0.33	200
M272749/M272710DC	3-723	503	660	29	4	1.5	1.9	2.9	1.9	0.35	322
EE243196/243251DC	3-725	525	625	16	4	1	2	3	2	0.34	127
EE626210/626321D		585	762		9.7	3.3	1.52		2.26	0.44	466
LM377449/LM377410DC	3-724	587	715	26	5	1	1.9	2.9	1.9	0.35	247
											EE843220/843292D
	LY-3014										197
	LY-3010										320



Taper Roller Bearings

double-row

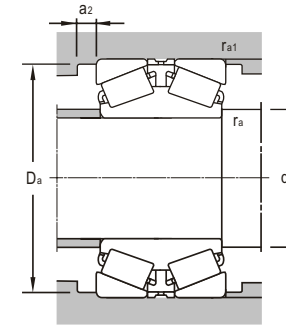
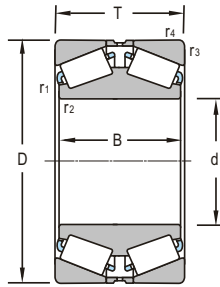

d 70~280mm

Boundary Dimensions						Basic Load Ratings	
<i>d</i>	<i>D</i>	<i>T</i>	<i>B</i>	<i>r</i> _{1,2min}	<i>r</i> _{3,4min}	Dynamic <i>C</i>	Static <i>C</i> ₀
mm						kN	
70	110	56	56	0.8	1.5	169	298
80	110	50	50	0.5	1	125	246
100	215	110	110	2	3	713	1100
	180	74	74	1.5	2.5	473	720
105	160	86	86	2.5	1	411	796
110	240	118	118	1.5	4	662	1040
	170	94	94	2.5	2	456	928
130	280	144	132	1.5	4	1050	1560
150	320	164	150	1.5	4	1250	2210
177.8	288.925	123.825	123.825	1.6	3.2	1091	1870
190	288.5		109	2	2.5	887	1880
	288.5		100	2	2.5	818	1690
200	340	140	140	3	2.5	1470	2860
	380	180	180	4	4	1750	3080
203.2	368.3	158.75	152.4	3.2	3.2	1500	2690
220.662	314.325		115.888	1.5	3.3	1050	2510
254	347.662	101.6	101.6	3.5	3.5	850	1386
	438.15	165.1	165.1	3.2	6.4	1917	3555
	358.775	130.175	130.175	3.5	3.3	1310	3110
260	360	134	134	3	2.5	1020	2581
	420	170	170	5	4	2240	4600
	420	170	170	5	4	2240	4600
266.7	355.6		230.188	1.5	3.3	1840	5260
280	380	134	134	3	2.5	1180	2780
	400	180	180	3	3	1710	4740

Bearing Designations		Mounting Dimensions					Calculation Factors				Mass	
Present	Original	<i>d</i> _{amax}	<i>D</i> _{amin}	<i>a</i> ₂	<i>r</i> _{amax}	<i>r</i> _{a1max}	<i>Y</i> ₁	<i>Y</i> ₂	<i>Y</i> ₀	<i>e</i>	kg	
		mm										
	LY-3033										1.9	
	LY-3032										1.3	
45T202211-1F2		110	180	5	2	2	0.81	0.8	1.2	0.8	18.6	
30220/DF/YA											7.78	
	LY-3016	117	145	5	2	2	0.28	2.3	3.6	2.3	6.04	
370622	87722	138	185	5	1.5	3	0.8	0.8	1.2	0.8	25.1	
	LY-3017	122	155	4	1.5	2	0.29	2.3	3.5	2.3	7.68	
31326/DF	3-772	158	218	8	1.5	3	0.83	0.8	1.2	0.8	42.4	
31330X/DF		181	251	9	3	1	0.83	0.81	1.2	0.8	58.5	
HM237546D/HM237510	3-759	191	266	5	1	2.5	0.32	2.1	3.2	2.1	31.5	
372038X2		208	258				1.47	2.2	1.46	0.46	25.8	
372038		202	272				1.5	2.2	1.4	0.46	23.4	
374140		230	290	10	2.5	2	0.52	1.3	1.9	1.3	52.6	
45T403818-1Y2		218				3	0.8				91.3	
EE420800D/421450	3-758	240	310	5	2.5	2.5	0.4	1.7	2.5	1.6	76.2	
M244249DW/M244210		235	293		1.5		2.03		3.02	0.33	28.7	
LM249747D/LM249710		268	325	5	2.5	2.5	0.33	2	3	2	24.5	
EE73810D/738172	3-757	283	400	5	2.5	5	0.36	1.9	2.8	1.8	105	
M249748D/M249710/HC3											41.9	
372952 K		274				2.5	0.37				42.3	
370652		290	395	10	4	3	0.33	2	3	2	93.1	
370652/HC		290	395	10	4	3	0.33	2	3	2	93.1	
LM451349D/GWJ2/10J2/10D.J2		288	318				1.8	2.7		1.8	0.37	59.4
372956X2K		300	360	3	2.5		0.29	2.3	3.5	2.3	46.8	
370656K											80.9	

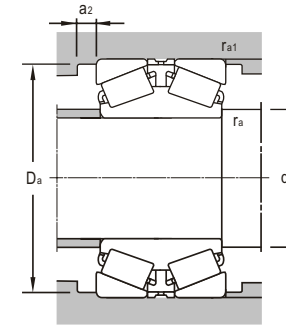
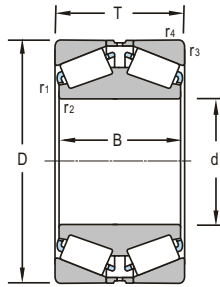

d 290~400mm

Boundary Dimensions						Basic Load Ratings	
d	D	T	B	r _{1,2min}	r _{3,4min}	Dynamic C	Static C ₀
mm						kN	
290	450		180	2.5	4	2140	4710
300	560	170	170	5	5	2280	3940
	560	170	170	5	5	2870	3340
300.038	422.275		150.813	3.3	3.3	1760	4210
305	480	200	200	3	4	2020	4200
	559.867	170.434	169.977	3.3	4.8	2304	4840
305.07	500		200	6.4	4.8	2370	5100
317.5	422.275		128.588	1.5	3.3	1650	3670
	447.675	158.75	158.75	3.2	3.2	1840	4640
320	620	280	280	5	5	5220	10300
	620	280	280	5	5	5220	10300
333.375	469.9		166.688	2	3	2080	5340
340	580		190	5	5	3060	6360
342.9	533.4	146.05	139.69	3.3	3.3	2160	4420
360	480		160	3	5	1970	5380
	560		160	3	5	2160	4560
	600	242	242	5	5	4350	9280
	680		330	2.5	5	5890	12300
368.3	523.875	185.738	185.738	3.3	6.4	2450	6730
380	567.5		180	2	4	2460	6230
	570		180	2	4	2460	6230
384.175	546.1	193.675	193.675	3.2	6.4	3030	8100
390	567.5	180	180	2	4	2460	6230
393.7	546.1		138.112	1.5	6.4	1930	4840
400	650		240	6.4	6.4	3310	7420

Bearing Designations		Mounting Dimensions					Calculation Factors				Mass
Present	Original	d _{amax}	D _{amin}	a ₂	r _{amax}	r _{a1max}	Y ₁	Y ₂	Y ₀	e	kg
		mm									
370658		312	382				1.07	1.59	1.05	0.64	102
370660/HC		322	535	5	5	4	0.81	0.8	1.2	0.8	196
370660-LS/HCC9		322	535	5	5	4	0.85	0.8	1.2	0.8	189
HM256849D-2/HM256810-2		322	394		3.3	3.3	2		2.99	0.34	66.3
45T614820-1GYZ		325	460	4	3	3	0.87	0.9	1.2	0.9	133
HM959649D/HM959618	3-770S	350	436	5	3	3	0.87	0.9	1.2	0.9	187
LY-3034K1		340	435				0.78	1.16	0.76	0.87	157
LM258648DW-1/LM258610-1		334	398		1.5		2.11		3.15	0.32	48.8
HM259049DE/HM259010		335	418	3.3	3.3		0.33	2	3	2	79.7
370664		385	512	10	5	4	0.43	1.6	2.3	1.6	414
370664-X2		385	512	10	5	4	0.43	1.6	2.3	1.6	414
HM261049DW-2/HM261010-2											96.7
LY-3103		370	510				1.13	1.68	1.1	0.6	207
EE971355D/972100		372	497	3.3	3.3		0.33	2	3	2	115
372972X2		370	448				2.05	3.05	2	0.33	81
370672/HCYA											139
374172X2		396	550	11	4	4	0.44	1.5	2.3	1.5	282
370672-2		418	630				1.1	1.6	1.07	0.62	552
HM265049TD/HM265010S		385	510	6.4	3.3		0.33	2	3	2	140
JM966741DW/JM966711W											160
LY-3108		412	548				0.9	1.35	0.89	0.74	163
HM266449DW/HM266410		407	508	6.4	3.3		0.33	2	3	2	152
JM966748DW/JM966711W-1		411	522	7	2	3	0.74	0.9	1.4	0.9	158
LM7674SOL/LM76710		418	510			1.5	1.42		2.12	0.47	98
LY-3042K10		420	548				0.78	1.16	0.76	0.87	304



Taper Roller Bearings

double-row

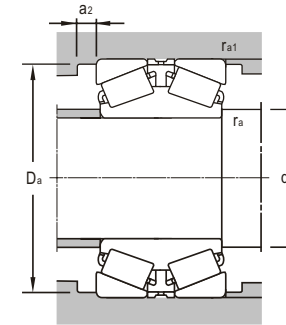
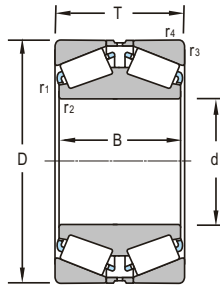

d 409.575--600.5mm

Boundary Dimensions						Basic Load Ratings	
<i>d</i>	<i>D</i>	<i>T</i>	<i>B</i>	<i>r</i> _{1,2min}	<i>r</i> _{3,4min}	Dynamic <i>C</i>	Static <i>C</i> ₀
mm						kN	
409.575	546.1	161.925	161.925	1.5	6.4	2160	6260
415.925	590.55	209.55	209.55	3.3	6.4	3520	9230
419.227	736.448	406.4	406.4	6	6	5294	10100
420	560	207.5	207.5	3	5	2890	7900
431.902	685.698	254	253.873	3.2	6.4	5080	11600
447.675	635	223.838	223.838	3.3	6.4	3800	10800
460	680		180	2.5	6	2740	6330
	860		380	2.5	5	8860	18700
	910		420	10	10	9270	18000
	950		450	6	5	11400	24400
480	950		440	9.5	9.5	10700	22200
	950	480	450	6	6	11400	24400
	950	500	500	6	6	12100	27000
482	655		160	3.3	3	2540	6560
489.026	634.873	152.4	152.4	3.3	3.3	2380	6990
500	720		185	6	6	3130	7360
501.65	673.1	184.15	184.15	3.3	6.4	3410	9380
520	715		180	2	5	3450	8770
540	860	256		7.5	7.5	5460	12100
571.5	812.8	285.75	285.75	3.2	6.4	4548	9192
580	830		280	3	6	6340	16600
595.312	844.55	296.862	296.862	6	6	4896	10668
600.5	819		172	6	6	3620	9020

Bearing Designations		Mounting Dimensions					Calculation Factors				Mass
Present	Original	<i>d</i> _{amax}	<i>D</i> _{amin}	<i>a</i> ₂	<i>r</i> _{amax}	<i>r</i> _{a1max}	<i>Y</i> ₁	<i>Y</i> ₂	<i>Y</i> ₀	<i>e</i>	kg
		mm									kg
M667947DW/M667910							0.43	1.6	2.3	1.6	110
M268749DW/M268710		420	575	6.4	3.3		0.33	2	3	2	206
EE323166D/323290	87984	440	702	25	5	5	0.26	2.6	3.9	2.6	799
370684K		434				2.5	0.3				143
EE328172DY/EE328269Y											391
M270749DW/M270710		475	591		6.4	3.3	0.33	2	3	2	236
373092X2/HC		473	623				0.78	1.16	0.76	0.87	220
374292X3/HC9		506	710				1.149		0.98	0.68	1107
LY-3099-1		526	820				1.32	1.97	1.29	0.52	1286
370692/C9YA											1675
370696X2/HC YB		560	760				0.97	1.44	0.94	0.7	1523
373396 X3		528	836	13	5	5	0.7	1	1.4	0.9	1623
370696/C9YA		540	833	7	5	5	0.7	1	1.4	0.9	1732
3706/482/HC		509	630				1.15	1.72	1.13	0.58	157
EE243193D/243250		508	602		3.3	3.3	0.35	1.9	2.9	1.8	130
500KD720HR		523	698				0.96	1.43	0.94	0.7	263
BT2B 332547/HA1							0.31	2.2	3.3	2.2	190
3706/520/HC		540	672				0.83	1.24	0.8	0.8	216
3706/540/HC YB		585	778	15	6	6	0.7	1	1.4	0.9	573
M278749D/278710	3-754	596	774	20	2.5	5	0.33	2	3	2	491
3706/580/HC/PS		602	802				2.14	1.05	2.1	0.31	507
M280049D/M280010	879/595	625	804	20	5	5	0.33	2	3	2	523
3706/600.5/HC		630	770				1.67	2.48	1.63	0.4	273

